

# Operator's Manual



# McELROY

[www.mcelroy.com](http://www.mcelroy.com)



## TracStar<sup>®</sup> 250 Fusion Machine

Patent No's. 5,814,182 6,212,748 6,212,747 6,021,832  
(other patents pending)

Manual: T2500702 6/05 REV A

Original Language: English



**California  
Proposition 65 Warning**

*Engine exhaust from this product  
contains chemicals known to the State  
of California to cause cancer, birth  
defects, or other reproductive harm.*



# Introduction



## Thank you for purchasing this McElroy product

The McElroy TracStar® 250 self-contained, self-propelled, all terrain fusion machine, and is designed to produce consistently high quality polyolefin pipe butt fusion joints with a minimum of operator effort.

The TracStar® 250 model fuses 2" IPS (63mm) minimum to 250mm maximum pipe.

With reasonable care and maintenance, this machine will give years of exemplary service.

Before operating this machine, please read this manual thoroughly, and keep a copy with the machine for future reference. This manual is to be considered part of your machine.

Always return the manual to the literature compartment.

Replacement manuals can be downloaded and printed from [www.mcelroy.com](http://www.mcelroy.com)

TX02101-3-1-03



PH02476-06-20-03

Patent No's. 5,814,182 6,212,748 6,212,747 6,021,832  
(other patents pending)

## World Class Training

This manual is intended as a guide only and does not take the place of proper training by qualified instructors. The information in this manual is not all inclusive and can not encompass all possible situations that can be encountered during various operations.

McElroy Manufacturing, Inc., offers advanced training classes to enhance efficiency, productivity, safety and quality. Training is available at our facility or on-site at your location. Call (918) 836-8611.

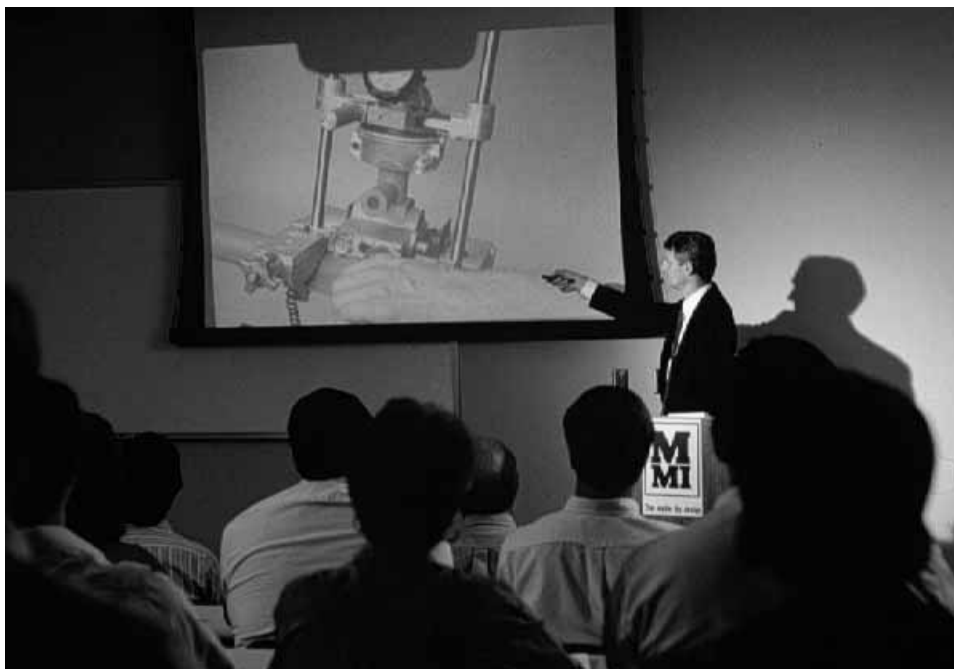

PH00917-8-15-97

TX01315-4-7-97



# Warranty



## LIMITED WARRANTY

McElroy Manufacturing, Inc. (McElroy) warrants all products manufactured, sold and repaired by it to be free from defects in materials and workmanship, its obligation under this warranty being limited to repairing or replacing at its factory and new products, within **3 years** after shipment, with the exception of purchased items (such as electronic devices, pumps, switches, etc.), in which case that manufacturer's warranty applies. Warranty applies when returned freight is prepaid and which, upon examination, shall disclose to have been defective. This warranty does not apply to any product or component which has been repaired or altered by anyone other than McElroy or has become damaged due to misuse, negligence or casualty, or has not been operated or maintained according to McElroy's printed instructions and warnings. This warranty is expressly in lieu of all other warranties expressed or implied. The remedies of the Buyer are the exclusive and sole remedies available and Buyer shall not be entitled to receive any incidental or consequential damages. Buyer waives the benefit of any rule that disclaimer of warranty shall be construed against McElroy and agrees that such disclaimers herein shall be construed liberally in favor of McElroy.

## RETURN OF GOODS

Buyer agrees not to return goods for any reason except upon the written consent of McElroy obtained in advance of such return, which consent, if given, shall specify the terms and conditions and charges upon which any such return may be made. Materials returned to McElroy, for warranty work, repair, etc., **must have a Return Material Authorization (RMA) number**, and be so noted on the package at time of shipment. For assistance, inquiry shall be directed to:

McElroy Manufacturing, Inc.  
 P.O. Box 580550  
 833 North Fulton Street Tulsa, Oklahoma 74158-0550  
 PHONE: (918) 836-8611, FAX: (918) 831-9285.  
 EMAIL: fusion@McElroy.com

**Note:** Certain repairs, warranty work, and inquiries may be directed, at McElroy's discretion, to an authorized service center or distributor.

## DISCLAIMER OF LIABILITY

McElroy accepts no responsibility of liability for fusion joints. Operation and maintenance of the product is the responsibility of others. We recommend qualified joining procedures be followed when using McElroy fusion equipment.

McElroy makes no other warranty of any kind whatever, express or implied; and all implied warranties of merchantability and fitness for a particular purpose which exceed the aforesaid obligation are hereby disclaimed by McElroy.

## PRODUCT IMPROVEMENT

McElroy reserves the right to make any changes in or improvements on its products without incurring any liability or obligation to update or change previously sold machines and/or the accessories thereto.

## INFORMATION DISCLOSED

No information of knowledge heretofore or hereafter disclosed to McElroy in the performance of or in connection with the terms hereof, shall be deemed to be confidential or proprietary, unless otherwise expressly agreed to in writing by McElroy and any such information or knowledge shall be free from restrictions, other than a claim for patent infringement, is part of the consideration hereof.

## PROPRIETARY RIGHTS

All proprietary rights pertaining to the equipment or the components of the equipment to be delivered by McElroy hereunder, and all patent rights therein, arising prior to, or in the course of, or as a result of the design or fabrication of the said product, are exclusively the property of McElroy.

## LAW APPLICABLE

All sales shall be governed by the Uniform Commercial Code of Oklahoma, U.S.A.

**Register your product online to activate your warranty:  
[www.McElroy.com/fusion](http://www.McElroy.com/fusion)**

(Copy information listed on the machine nameplate here for your records).

Model No. \_\_\_\_\_

Serial No. \_\_\_\_\_

Date Received \_\_\_\_\_

Distributor \_\_\_\_\_



# Table of Contents



## Equipment Safety

Safety Alerts . . . . .	1-1
Read and Understand . . . . .	1-1
General Safety . . . . .	1-2
Wear Safety Equipment . . . . .	1-2
Fuel Handling . . . . .	1-2
Units with Engines . . . . .	1-3
Carbon Monoxide . . . . .	1-3
Heater is Not Explosion Proof . . . . .	1-3
Electric Motors and Alternators are Not Explosion Proof. . . . .	1-3
Battery . . . . .	1-4
Electrical Safety . . . . .	1-4
Crush Points . . . . .	1-5
Facer Blades are Sharp . . . . .	1-5
Units with Hydraulics . . . . .	1-5
Keep Machine Away from Edge of Ditch . . . . .	1-6
Operating Fusion Machine . . . . .	1-6
Do Not Attempt to Tow Fusion Machine . . . . .	1-6
Heater is Hot. . . . .	1-6
Fusion Procedures . . . . .	1-7
Periodically Check Temperature. . . . .	1-7
Hearing Protection Required . . . . .	1-7
Positioning Fusion Machine . . . . .	1-7

## Overview

Theory of Heat Fusion . . . . .	2-1
Carriage Assembly . . . . .	2-2
Chassis. . . . .	2-2
Gas Powered Units . . . . .	2-3
Tach and Hour Meter for Gas Unit. . . . .	2-3
Oil Reservoir . . . . .	2-4
Hydraulic Oil Filter . . . . .	2-4
Hydraulic Manifold Block . . . . .	2-5
Hydraulic Cylinders . . . . .	2-6
Facer . . . . .	2-6
Insulated Heater Stand . . . . .	2-6
Heater . . . . .	2-7

COPYRIGHT © 2005  
 McELROY MANUFACTURING, INC.  
 Tulsa, Oklahoma, USA  
 All rights reserved

All product names or trademarks are property of their respective owners. All information, illustrations and specifications in this manual are based on the latest information available at the time of publication. The right is reserved to make changes at any time without notice.



# Table of Contents



## Operation

Read Before Operating . . . . .	3-1
Check Oil Level . . . . .	3-1
Gas Powered Units . . . . .	3-1
Moving Machine into Position . . . . .	3-1
Prepare Heater . . . . .	3-2
Set up Pipe Supports . . . . .	3-2
Install Clamping Inserts . . . . .	3-3
Check Hydraulic Pressure . . . . .	3-3
Loading Pipe Into Machine . . . . .	3-4
Positioning Pipe in Machine . . . . .	3-4
Facing the Pipe . . . . .	3-4
Remove Facer . . . . .	3-5
Position Carriage for Heater Insertion . . . . .	3-6
Check Heater Temperature . . . . .	3-6
Select the Fusion Position . . . . .	3-6
Inserting Heater . . . . .	3-7
Heating the Pipe . . . . .	3-7
Fusing the Pipe . . . . .	3-8
Opening Movable Jaws . . . . .	3-8
Opening Fixed Jaws . . . . .	3-9
Raise Pipe . . . . .	3-9
Position Pipe for Next Joint . . . . .	3-9
Install Next Piece of Pipe . . . . .	3-9

## Special Operations - In Ditch

Disconnect Hydraulic Hoses . . . . .	4-1
Remove Carriage Assembly from the Chassis . . . . .	4-1
Remove 3-Jaw Assembly from the Carriage . . . . .	4-2
Remove Facer from TracStar 250 . . . . .	4-3
Manual Facer Operation . . . . .	4-4
Outrigger . . . . .	4-4
Removing Top Jaws . . . . .	4-5
Lower 3-Jaw or 4-Jaw Carriage into Ditch . . . . .	4-5
Clamp Carriage Assembly to Pipe . . . . .	4-6
Attach Hydraulic Hoses . . . . .	4-7
Make Fusion Joint . . . . .	4-7
Remove Carriage Assembly from Ditch . . . . .	4-7
Reassemble Fusion Machine . . . . .	4-7

## Special Operations - Lifting the Machine

Heavy Overhead Load . . . . .	5-1
Crush Points . . . . .	5-1
Required Equipment . . . . .	5-1
Attach Slings . . . . .	5-2
Lifting Safety . . . . .	5-2



# Table of Contents



## Maintenance

Preventative Maintenance . . . . .	6-1
Washing the Machine . . . . .	6-1
Check Hydraulic Fluid . . . . .	6-1
Change Hydraulic Fluid and Filter . . . . .	6-1
Install/Remove Covers . . . . .	6-2
TracStar No.250 Belt Tension Adjustment . . . . .	6-3
Adjusting System Pressure . . . . .	6-3
Engine Oil System - Gasoline . . . . .	6-4
Check Gauge Calibration . . . . .	6-4
Clean Jaws and Inserts . . . . .	6-4
Clean Thrust Bearings . . . . .	6-5
Clean Eyebolt Threads . . . . .	6-5
Fasteners Must Be Tight . . . . .	6-5
Facer Blades . . . . .	6-5
Clean Heater Surfaces . . . . .	6-6
Bleeding Air From Hydraulic System . . . . .	6-6
Installing Butt Fusion Heater Adapter . . . . .	6-7
Adjusting Heater Temperature . . . . .	6-7
Heater Indicator Light . . . . .	6-7
Engine Maintenance . . . . .	6-8
Checking Track Tension . . . . .	6-8
Adjusting Track Tension . . . . .	6-9
Setting Engine Speed . . . . .	6-9

## Machine Maintenance Checklist

Machine Checklist . . . . .	7-1
-----------------------------	-----

## Determining Fusion Pressure

Determining Fusion Pressure . . . . .	8-1
---------------------------------------	-----

## Hydraulic Fluid

Hydraulic Fluid Characteristics . . . . .	9-1
---	-----

## Specifications

TracStar® 250 Fusion Machine Specifications . . . . .	10-1
---	------



# Fusion Equipment Safety



## Safety Alerts



This hazard alert sign appears in this manual. When you see this sign, carefully read what it says. **YOUR SAFETY IS AT STAKE.**

You will see the hazard alert sign with these words: **DANGER**, **WARNING**, and **CAUTION**.



WR00051-11-30-92



Indicates an imminently hazardous situation which, if not avoided, will result in death or serious injury.



Indicates a potentially hazardous situation which, if not avoided, could result in death or serious injury.



Indicates a hazardous situation which, if not avoided, may result in minor or moderate injury.



In this manual you should look for two other words: **NOTICE** and **IMPORTANT**.

**NOTICE:** can keep you from doing something that might damage the machine or someone's property. It may also be used to alert against unsafe practices.

**IMPORTANT:** can help you do a better job or make your job easier in some way.

TX00030-12-1-92

## Read and Understand

Do not operate this equipment until you have carefully read, and understand the "Safety" and "Operation" sections of this manual, and all other equipment manuals that will be used with it.

Your safety and the safety of others depends upon care and judgment in the operation of this equipment.

Follow all applicable federal, state, local, and industry specific regulations.

McElroy Manufacturing, Inc. cannot anticipate every possible circumstance that might involve a potential hazard. The warnings in this manual and on the machine are therefore not all inclusive. You must satisfy yourself that a procedure, tool, work method, or operating technique is safe for you and others. You should also ensure that the machine will not be damaged or made unsafe by the method of operation or maintenance you choose.

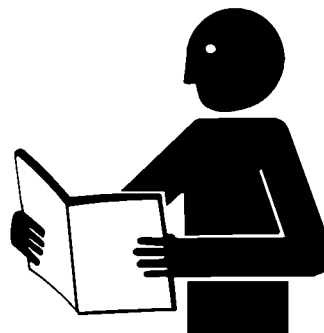

WR00052-12-1-92

TX00031-12-8-92





# Fusion Equipment Safety



## General Safety

Safety is important. Report anything unusual that you notice during set up or operation.

**LISTEN** for thumps, bumps, rattles, squeals, air leaks, or unusual sounds.

**SMELL** odors like burning insulation, hot metal, burning rubber, hot oil, or natural gas.

**FEEL** any changes in the way the equipment operates.

**SEE** problems with wiring and cables, hydraulic connections, or other equipment.

**REPORT** anything you see, feel, smell, or hear that is different from what you expect, or that you think may be unsafe.



SAFE1ST-12-22-92

TX00114-4-22-93

## Wear Safety Equipment

Wear a hard hat, safety shoes, safety glasses, and other applicable personal protective equipment.

Remove jewelry and rings, and do not wear loose-fitting clothing or long hair that could catch on controls or moving machinery.

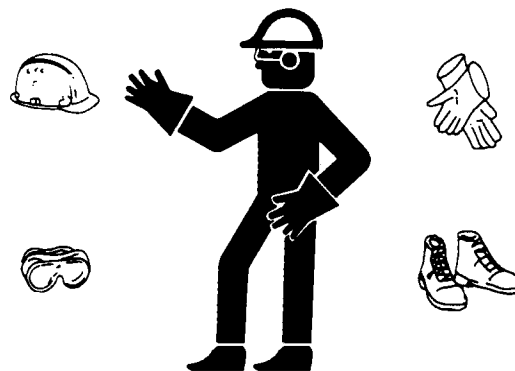

WR00053-12-2-92

TX00032-4-7-93

## Fuel Handling

**⚠ DANGER** Gasoline and diesel fuel are extremely flammable and their vapors will explode if ignited.

Do not fill the fuel tank while the engine is hot or running, as spilled fuel could ignite.

Refuel in a well ventilated area. Do not smoke or allow flames or sparks in the area where the engine is refueled, or where gasoline is stored.

Do not start the engine near spilled fuel. Wipe up spills immediately.

Make sure the fuel tank cap is closed and properly secured.

Avoid repeated or prolonged contact with skin or breathing of vapor.

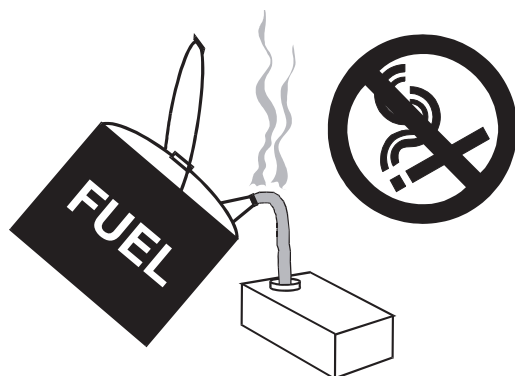

CD000365-2-19-97

TX00953-2-19-97



# Fusion Equipment Safety



## Units With Engines

**⚠ DANGER**

Combustion engines can cause explosions when operated in a hazardous environment. Do not operate gas or diesel powered machines in a hazardous environment.

When operating in a hazardous environment, keep engine and chassis in a safe area by using hydraulic extension hoses.

Help prevent fires by keeping machine clean of accumulated trash, debris and facer shavings.

TX01266-2-21-97



WR00080-4-12-93

## Carbon Monoxide

**⚠ DANGER**

Engine exhaust gases contain carbon monoxide which can cause severe nausea, fainting and death. Avoid inhaling exhaust fumes and never run the engine in a closed or confined area.

TX00954-5-14-96



WR00093-5-14-96

## Heater Is Not Explosion Proof

**⚠ DANGER**

The heater is not explosion proof. Operation of heater in a hazardous environment without necessary safety precautions will result in explosion and death.

If operating in a hazardous environment, the heater should be brought up to temperature in a safe environment, then **unplugged before entering** the hazardous atmosphere for fusion.

TX00100-9-16-94



WR00034-11-30-92

## Electric Motors and Alternators are Not Explosion Proof

**⚠ DANGER**

Electric motors are not explosion proof. Operation of these components in a hazardous environment without necessary safety precautions will result in explosion and death.

When operating in a hazardous environment, keep pump motor and chassis in a safe area by using hydraulic extension hoses.

TX00424-8-12-94



WR00080-4-12-93



# Fusion Equipment Safety



## Battery



Do not expose the battery to flames or electrical sparks. Hydrogen gas generated by battery action is explosive. Blindness or serious injury can result from an exploding battery.



CD001776-9-14-95



Do not allow battery fluid to contact your skin, eyes, fabrics, or painted surfaces. Sulfuric acid can cause burns. After touching a batter or battery cap, do not touch or rub your eyes.

Thoroughly wash your hands. If the acid contacts your eyes, skin or clothing, immediately flush with water for at least 15 minutes and seek medical attention.



CD001777-9-14-95

TX00650-9-14-95

## Electrical Safety



Always ensure power cords are properly grounded. It is important to remember that you are working in a wet environment with electrical devices. Proper ground connections help to minimize the chances of an electric shock.

Frequently inspect electrical cords and unit for damage. Have damaged components replaced and service performed by a qualified electrician.

Do not carry electrical devices by the cord.

**NOTICE:** Always connect units to the proper power source as listed on the unit, or in the owner's manual. On units with two power cords, plug each cord into separate power circuits. Do not plug into both outlets of one duplex receptacle.

**NOTICE:** Disconnect the machine from the power source before attempting any maintenance or adjustment.



WR00055-4-7-93



WR00025-11-30-92

TX00105-4-12-93



# Fusion Equipment Safety



## Crush Points

### ⚠ WARNING

Hydraulically operated jaws are operated under pressure. Anything caught in the jaws will be crushed. Keep fingers, feet, arms, legs, and head out of the jaw area. Always check pipe alignment with a pencil or similar object.

TX00103-4-6-93



WR00012-12-4-92

## Facer Blades Are Sharp

### ⚠ WARNING

Facer blades are sharp and can cut. Never attempt to remove shavings while the facer is running, or is in the facing position between the jaws. Use care when operating the facer, and when handling the unit.

**NOTICE:** Disconnect power from the facer, and remove the facer blades before attempting any maintenance or adjustment.

**NOTICE:** Never extend the blade beyond the inner or outer circumference of the facer.

TX02378-1-24-05

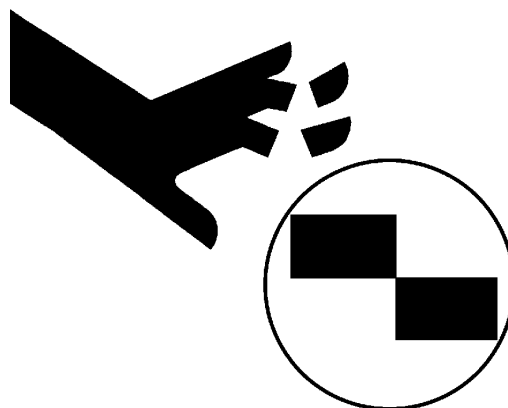

WR00073-4-6-93

## Units With Hydraulics

Although the hydraulic pressures in this machine are low compared to some hydraulically operated equipment, it is important to remember that a sudden hydraulic oil leak can cause serious injury, or even be fatal if the pressure is high enough.

### ⚠ WARNING

Escaping fluid under pressure can penetrate the skin causing serious injury. Keep hands and body away from pinholes which eject fluid under pressure. Use a piece of cardboard or paper to search for leaks. If any fluid is injected into the skin, it must be immediately removed by a doctor familiar with this type of injury.

**NOTICE:** Wear safety glasses, and keep face clear of area when bleeding air from hydraulic system to avoid spraying oil into eyes.

TX00110-8-23-95

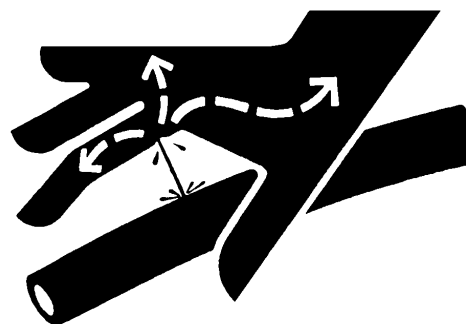

WR00078-4-8-93



# Fusion Equipment Safety



## Keep Machine Away From Edge of Ditch

**⚠️ WARNING** Heavy equipment too close to a ditch can cause the walls of the ditch to cave-in. Keep the machine far enough away from the edge of the ditch to prevent injury to personnel and equipment from a cave-in.

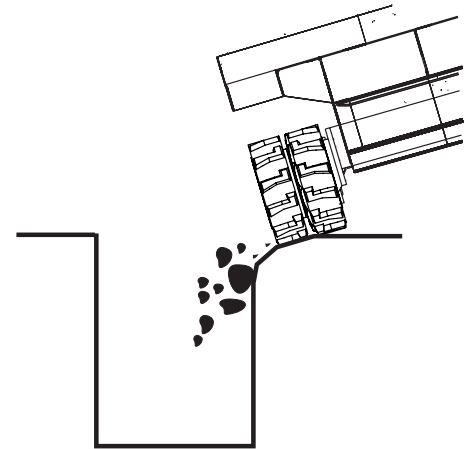

CD00408b-9-27-00

TX01447-12-30-97

## Operating Fusion Machine

Place fusion machine on as level ground as possible. If it is necessary to operate machine on unlevel grade, make sure that the ground is stable. Some unstable conditions may be ice, snow, mud and loose gravel.

**⚠️ WARNING** For operation safety, never operate the machine on a grade steeper than 30 %. (A 3 foot elevation change in 10 feet)

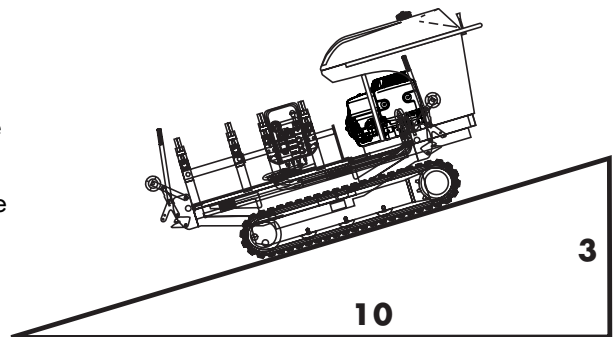

CD00402c-9-27-00

TX01902-11-15-00

## Do Not Attempt to Tow Fusion Machine

**⚠️ CAUTION** The machine is not designed for towing. Attempting to tow the machine can result in machine damage. Always transport the machine by flat bed truck or similar means, and make sure that unit is properly secured.

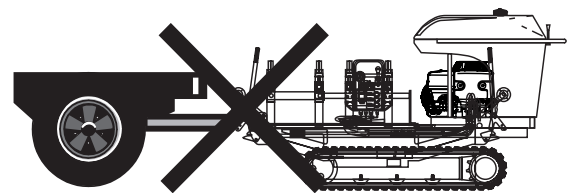

CD00401b-9-27-00

TX01888-11-15-00

## Heater is Hot

**⚠️ CAUTION** The heater is hot and will burn clothing and skin. Keep the heater in its insulated heater stand or blanket when not in use, and use care when heating the pipe.

**NOTICE:** Use only a clean non-synthetic cloth such as a cotton cloth to clean the heater plates.

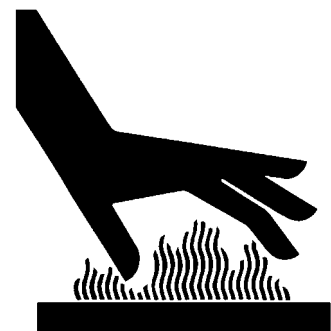

WR00030-2-10-93

TX00104-8-12-94



# Fusion Equipment Safety



## Fusion Procedures

Obtain a copy of the pipe manufacturer's procedures for the pipe being fused. Follow the procedure carefully, and adhere to all specified parameters.



Failure to follow pipe manufacturer's procedure could result in a bad joint. Always follow pipe manufacturer's procedures.

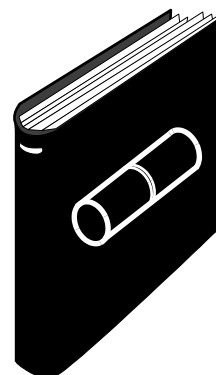

WR00079-1-24-96

TX00113-4-12-93

## Periodically Check Temperature

**NOTICE:** Incorrect heating temperature can result in bad fusion joints. Check heater plate surface temperature periodically with a properly calibrated pyrometer, and make necessary adjustments.

The thermometer on heaters indicates internal temperature, and should be used as a reference only.

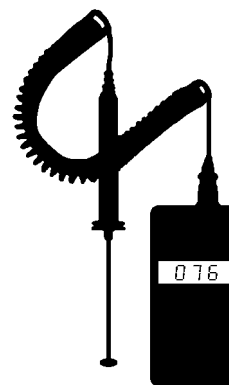

WR00077-4-16-93

TX00107-11-13-95

## Positioning Fusion Machine

Place fusion machine on as level ground as possible. If it is necessary to operate machine on unlevel grade, chock the tracks and block the unit to make it as stable as possible.

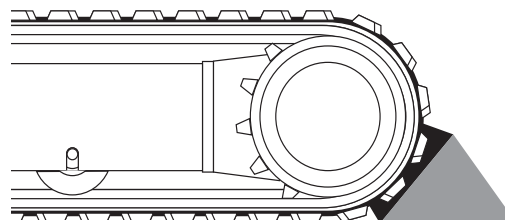

CD00633-9-27-00

TX01889-11-15-00

## Hearing Protection Required

When operating machine for more than 4 hours per day wear hearing protection.

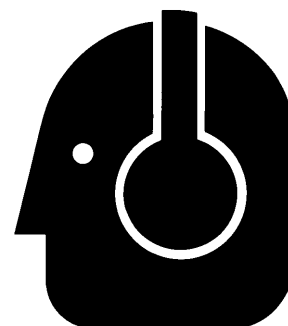

WR00028-1-24-96

TX01890-11-15-00

## Theory of Heat Fusion

The principle of heat fusion is to heat two surfaces to a designated temperature, and then fuse them together by application of force. This pressure causes flow of the melted materials, which causes mixing and thus fusion. When the polyethylene material is heated, the molecular structure is transformed from a crystalline state into an amorphous condition. When fusion pressure is applied, the molecules from each Polyethylene part mix. As the joint cools, the molecules return to their crystalline form, the original interfaces are gone, and the fitting and pipe have become one homogeneous unit. The joint area becomes as strong as the pipe itself in both tensile and pressure conditions.

The principle operations include:

- Clamping** The pipe pieces held axially to allow all subsequent operations to take place.
- Facing** The pipe ends must be faced to establish clean, parallel mating surfaces perpendicular to the centerline of the pipes.
- Alignment** The pipe ends must be aligned with each other to minimize mismatch or high-low of the pipe walls.
- Heating** A melt pattern that penetrates into the pipe must be formed around both pipe ends.
- Joining** The melt patterns must be joined with a specified force. The force must be constant around the interface area.
- Holding** The molten joint must be held immobile with a specified force until adequately cooled.
- Inspecting** Visually examine the entire circumference of the joint for compliance with standards established by your company, customer, industry, federal, state, or local regulations.

Each pipe manufacturer has a slightly different approach for fulfilling the heating, joining, and holding phases, but the end result is the same – a fusion joint that is as strong or stronger than the pipe itself.

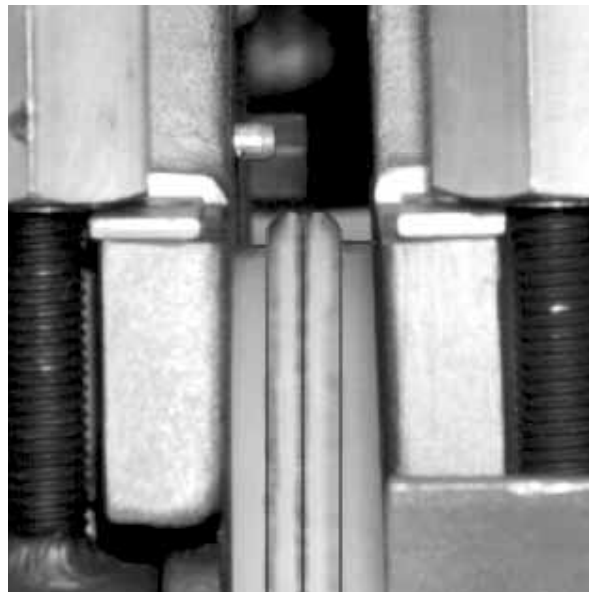

PH00363B-1-496



# Overview



## Carriage Assembly

The carriage assembly consists of two fixed jaws and two hydraulically operated movable jaws bolted to the skid. For remote operation the carriage can be set in ditch and connected to the machine with optional hydraulic extension hoses. The carriage assembly (A) can be disconnected from the chassis (B) and removed for remote operation. The optional extension hose kit is required for this operation.

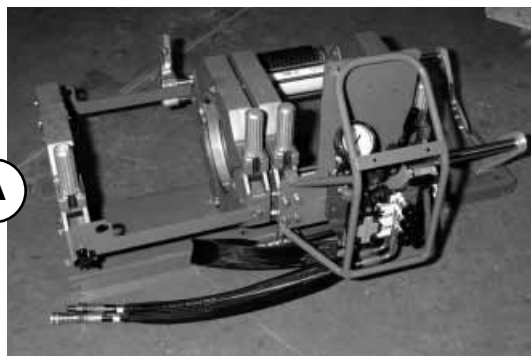

PH02442-03-10-03

For tight installations the outer fixed jaw and skid can be removed from the carriage for an even more compact fusion unit.

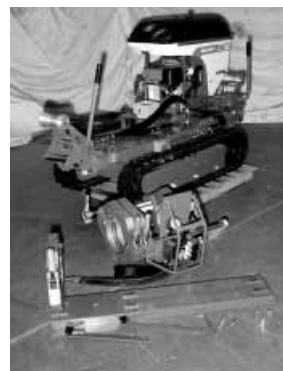

PH02452-03-10-03

TX01891-11-15-00

## Chassis

The carriage assembly is mounted on a track driven chassis for easy loading and movement along the pipe line.

The engine powers an alternator, used to power the heater, and a hydraulic pump, which powers the fusion machine and the track drive. A belt drive is used to transfer the power. The hydraulic reservoir is mounted above the engine. The fuel tank and battery are installed between the tracks.

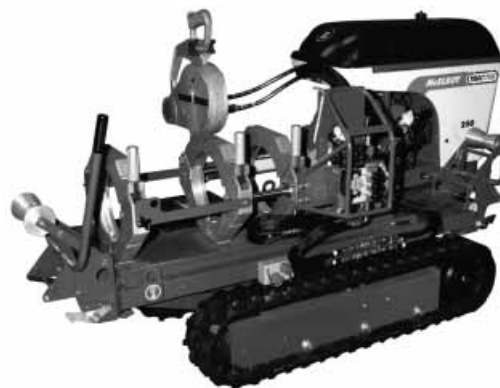

PH02476-06-20-03



PH01959-11-15-00

TX01854-11-15-00





# Overview



## Gas Powered Units

Read the operating and maintenance instructions for the engine before operating.

The engine is a single cylinder, overhead valve, air cooled design. It uses a vacuum operated fuel pump.

The fuel shutoff valve is located by the carburetor.

The throttle control and keyswitch to start the engine are at the rear of the machine. As shown on the label, move the throttle lever to the far left for choke.



PH02477-06-20-03



PH02243-1-10-02

TX02318-10-25-04

## Tach and Hour Meter for Gas Unit

When the unit is running, the engine speed is displayed. When the unit is not running, total hours of engine operation are displayed.



PH01988-11-15-00

TX02103-4-1-03



# Overview



## Oil Reservoir

The oil reservoir is located above the engine.

Refer to the "Hydraulic Fluids" section of this manual for hydraulic oil recommendations.



PH02477-06-20-03

TX02500-6-3-05

## Hydraulic Oil Filter

This machine is equipped with a 10 Micron filter on the return side of the hydraulic system.



PH01916-11-15-00

TX01893-11-15-00



## Hydraulic Manifold Block

Mounted on this block are a carriage directional control valve, a pressure reducing selector valve, three pressure reducing valves, and a 1500 psi gauge.

- A) The carriage control valve, mounted on the top of the manifold, determines whether the carriage is moving left, right, or is in neutral.
- B) A 1500 psi gauge is mounted on top of the manifold.
- C) The selector valve, mounted on the front of the manifold, selects a reduced pressure from one of the pressure reducing valves.

Each pressure reducing valve is labeled with a different function:

- D) The top valve adjusts facing pressure to a maximum of 400 psi.
- E) The middle valve adjusts heating pressure to a maximum of 400 psi.
- F) The bottom valve adjusts fusion pressure to a maximum of 1500 psi.

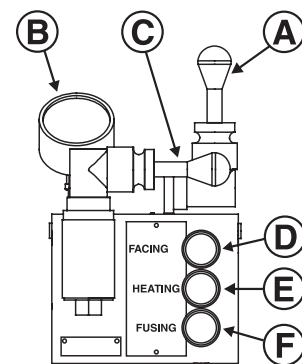
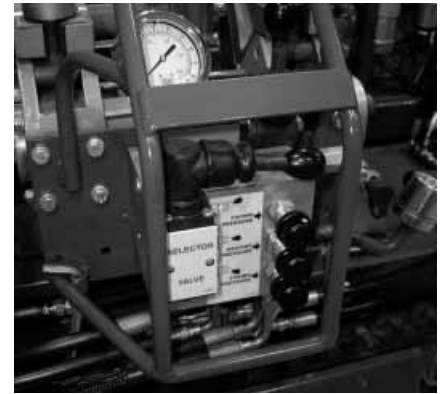



# Overview



## Hydraulic Cylinders

HIGH FORCE hydraulic carriage cylinders are painted green. High force cylinders are used when higher interfacil pressures are required, when handling heavy wall pipe, or when large drag factors need to be overcome.

MEDIUM FORCE cylinders are painted orange and have approximately half the total effective piston area as High Force cylinders. The cylinders move faster and are normally used for medium density pipe and when lower interfacial pressures are used.

LOW FORCE cylinders are painted yellow. These cylinders should be selected when fusing pipe with a very low interfacial pressure (22 psi).

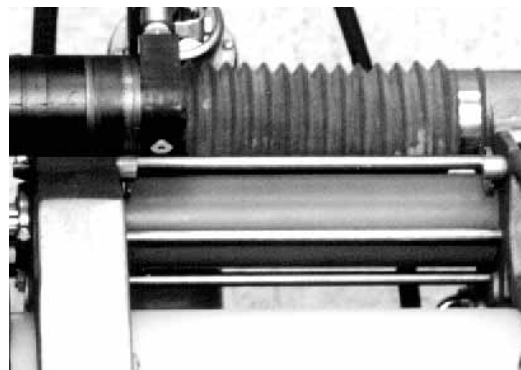

PH00410-9-22-94

TX01270-2-21-97

## Facer

The facer is a McElroy Rotating Planer-Block design. The block rotates on a ball bearing and is chain driven by a hydraulic motor.

**NOTICE:** Never extend the blade beyond the inner or outer circumference of the facer.



PH02446-03-10-03

TX02501-6-3-05

## Insulated Heater Stand

The heater should always be stored in the insulated heater stand or blanket for protection of the operator and to minimize heat loss and risk of mechanical damage.



PH02334-07-08-02

TX00363-9-15-94



## Heater

### **DANGER**

Heater is not explosion proof. Operation of heater in a hazardous environment without necessary safety precautions will result in explosion and death.

If operating in a hazardous environment, heater should be brought up to temperature in a safe environment, then unplugged before entering the hazardous atmosphere for fusion.

The heater has a green indicator light which will flash on and off. This indicates that the controller is operating normally. If the green indicator is not flashing then the controller may not be operating properly. If this occurs, disconnect power and have the heater repaired by an McElroy Authorized Service Center.

The heater temperature is controlled by a microprocessor. It has a red indicator light on the handle at the bottom of the temperature scale. When the heater is plugged in and preheating the light glows steadily until the set temperature is reached. The light then goes off and on slowly as the heater maintains temperature.

The heater body is not coated. Coated butt fusion heater plates are available for all butt fusion applications.

**NOTICE:** The heater should never be used without butt fusion heater plates installed.

To prevent a build-up of plastic pipe residue from accumulating on the heater plates (loss of surface temperature and pipe sticking may result), the heater plates should be cleaned with a non-synthetic cloth before and after every fusion joint.



PH023347-08-02



PH023137-08-02



PH023177-08-02



# Operation



## Read Before Operating

Before operating this machine, please read this manual thoroughly and keep a copy available for future reference.

Return manual to the protective storage box when not in use. This manual is to be considered part of your machine.

TX00401-9-15-94

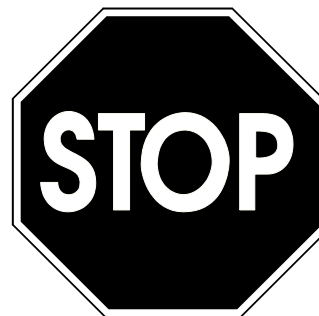

Stop-1228-95

## Check Oil Level

Check oil level in the reservoir and verify that oil is visible in the strainer.

Refer to the "Hydraulic Fluids" section of this manual for hydraulic oil recommendations.

If oil is not visible in the reservoir strainer, fill reservoir until oil is visible in the strainer.

Do not overfill reservoir. The oil will expand as it heats up.

Never allow dirt, water, or other foreign matter to enter the tank.

Use only clean oil from an unopened container.

TX02323-10-25-04



PH02714-10-25-04

## Gas Powered Units

Read the operating and maintenance instructions for the engine before operating.

Open facer valve and disconnect heater before starting engine. Set the engine throttle lever to choke position. Turn key to the right to start.

Gradually back off the choke position as engine warms up. Close the facer valve to allow the machine to build pressure.

Turn key to the left to stop.

TX02325-10-25-04



PH01926-11-15-00

## Moving Machine Into Position

Make sure all personnel are safely clear of the machine before moving.

Stand behind the machine console.

Move both track control levers forward to go in a straight line. Release the levers to stop. Moving just the right track forward turns the machine to the left. Moving just the left track forward turns the machine to the right. Pull levers back to back up.

TX01491-3-2-98



PH01969-11-15-00



# Operation



## Prepare Heater



Heater Is Not Explosion Proof. Operation of heater in a hazardous environment without necessary safety precautions will result in explosion and death.

If operating in a hazardous environment, heater should be brought up to temperature in a safe environment, then unplugged before entering the hazardous atmosphere for fusion.

Install butt fusion heater plates.

**NOTICE:** The heater should never be used without butt fusion heater plates installed. Refer to the "Maintenance" section of this manual for installation procedure.

Place heater in insulated heater stand.

Plug heater into the appropriate outlet on machine.

**IMPORTANT:** Engine must be in high speed to provide electric power to the heater.

Refer to the "Maintenance" section of this manual for instructions how to adjust heater temperature.

Allow heater to warm-up to operating temperature.

TX02310-10-25-04



PH02334-7-08-02



PH01922-06-20-03

## Set up Pipe Supports

Set up pipe stands and adjust height so the pipe is in line with the jaws.

TX00367-9-15-94



PH01900-11-15-00



PH02556-6-6-05



# Operation



## Install Clamping Inserts

Select and install appropriate clamping inserts for the pipe that is being fused.



PH02447-03-10-03

TX00368-9-15-94

## Check Hydraulic Pressure

The pressure gauge on the manifold block indicates the pressure at the carriage valve. How much pressure depends on the position of the selector valve and the pressure set on the specific pressure reducing valve. With the selector valve up, the facing pressure can be set. It may be necessary to adjust the carriage pressure, while facing, with the top pressure reducing valve to control facing pressure.

Shift the selector valve to the center position, and set the heating pressure (if required). If heating pressure is not required, set the pressure reducing valve at its lowest setting, or the drag pressure, whichever is higher.

With the selector valve in the down position, the fusion pressure can be set.

The heating and fusion pressures can be calculated using the enclosed fusion pressure calculator. Always add drag pressure to the calculated gauge pressure. Drag pressure should be determined using the following procedure:

After facing the pipe, move the carriage so that the pipe ends are approximately 2" apart.

Shift the carriage control valve to the middle (neutral) position.

Select the heating mode, and adjust the middle pressure reducing valve to its lowest pressure by turning the valve counterclockwise.

Shift the carriage control valve to the left.

Gradually increase the pressure by turning the valve clockwise. Increase the pressure until the carriage moves.

Quickly reduce the heating pressure valve counterclockwise until the carriage is just barely moving.

Record this actual drag pressure.

Take the pressure, determined from the calculator, then add the actual measured drag pressure. This will be the actual fusion pressure to set with the bottom pressure reducing valve.

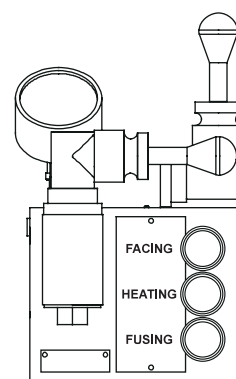

CD00138B-9-12-94



PH01761-11-1-99

TX01894-11-15-00





# Operation



## Loading Pipe Into Machine

Clean the inside and outside of pipe ends that are to be fused.

Open the upper jaws and insert pipe in each pair of jaws with applicable inserts installed. Let the ends of the pipe protrude about 1" past the face of the jaws.

TX02339-10-25-04

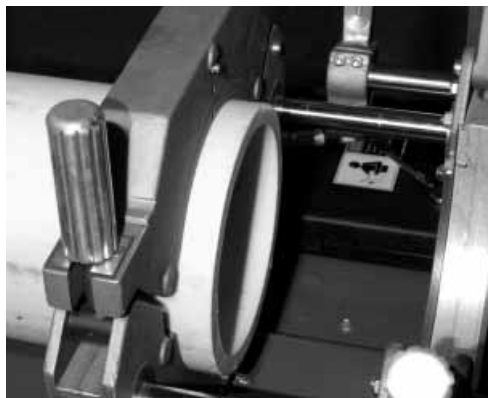

## Positioning Pipe In Machine

Swing the facer into place. With the carriage control valve lever, move the carriage toward the fixed jaws, while watching the gap at each end of the facer rest buttons. When the pipe is in contact with the facer, this gap indicates the amount of material that will be trimmed from the pipe end. Assure sufficient material will be removed for a complete face off. Tighten the clamp knobs on the outside jaws. Hand tighten the inside clamp knobs.

TX00372-9-15-94

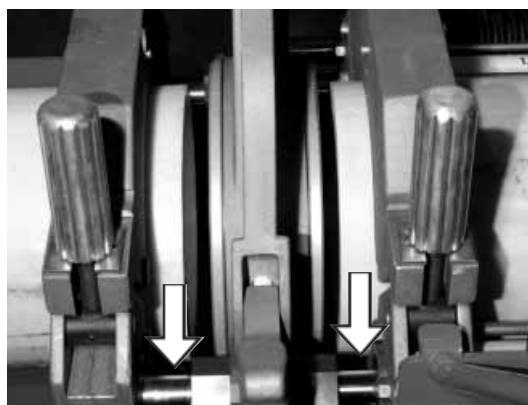

## Facing the Pipe

Move the carriage to the right.

Open the ball valve on the facer motor.

Assure the selector valve handle is up in the facing position.

Move the carriage control valve to the left.

If the facer stalls, adjust the facing pressure so the facer continues to cut.

**IMPORTANT:** When drag pressure exceeds 300 psi it is necessary to move the carriage to the left bringing the pipe ends into contact with the facer before opening the facer valve.

Let the carriage bottom out on facer stops. Turn facer off. Move the carriage to the right so the facer can be removed.

TX01872-11-8-00

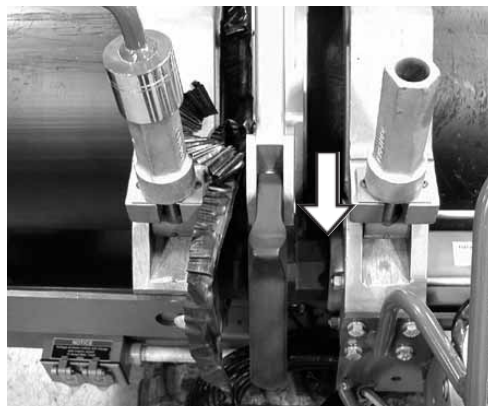
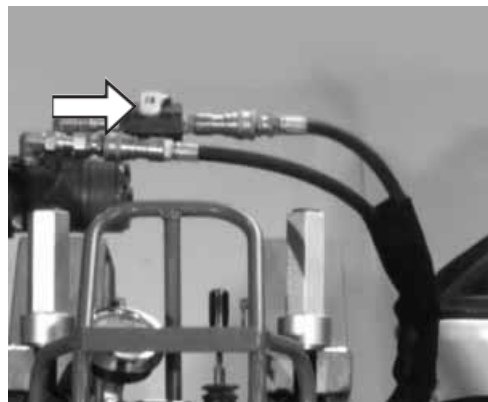



## Remove Facer

Swing the facer out to the storage position.

Remove chips from pipe ends.

Do not touch faced pipe ends.

Inspect both pipe ends for complete face off. If the face off is incomplete, return to **Loading Pipe into Machine**.



PH003629-14-94

Move the carriage to the left until ends of pipe butt together.

Check pipe joint for proper alignment.

**WARNING** Do not use finger to check for hi/lo (misalignment). The unit is under pressure, and slippage could result in crushed fingers. Always keep hands clear of the jaw area.

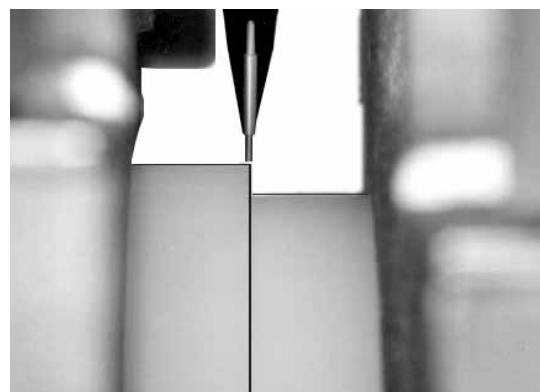

PH003669-12-94

If pipe is not lined up, tighten the high side jaw to bring into alignment.

**IMPORTANT:** Always tighten the side that is higher, never loosen the low side.

When the pipe is properly aligned tighten outside clamps to insure against slippage.

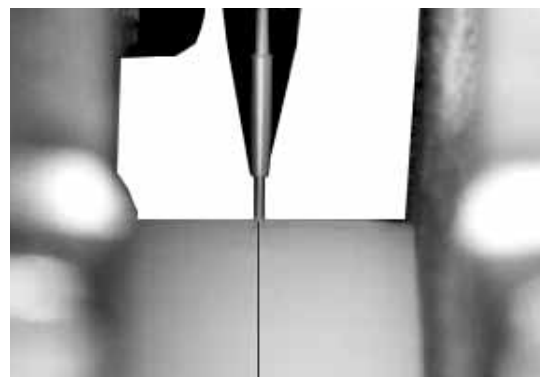

PH003579-12-94

Ensure there is no unacceptable gap between the pipe ends. If there is an unacceptable gap, return to **Loading Pipe into Machine**.

**NOTICE:** When clamping, do not over-tighten the clamp knobs because machine damage can result. Check to see if there is space between the upper and lower jaws. If the two jaws are touching, do not continue to tighten.

Bring the pipe ends together under fusion pressure to check for slippage. If slippage occurs, return to **Loading Pipe into Machine**.



PH02448-03-10-03



# Operation



## Position Carriage for Heater Insertion

Move carriage to the right to open a gap large enough to insert the heater.

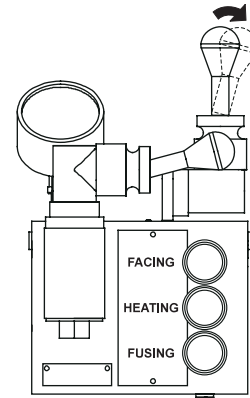

TX00374-9-15-94

CD00138D-9-12-94

## Check Heater Temperature

**CAUTION** Incorrect heating temperature can result in questionable fusion joints. Check heater plates periodically with a pyrometer and make necessary adjustments.

Check heater surface temperature.

Refer to the pipe manufacturer's recommendations for proper heater temperature.

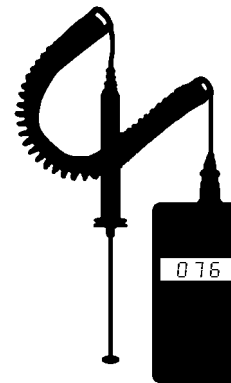

**IMPORTANT:** The dial thermometer on the heater indicates internal temperature which varies from the actual surface temperature.

The dial thermometer can be used as reference once the surface temperature has been verified.



TX00375-11-1-94

WR00077-4-16-93

PH00420-11-1-94

## Select the Fusion Position

Move selector valve handle down to the fusing position.

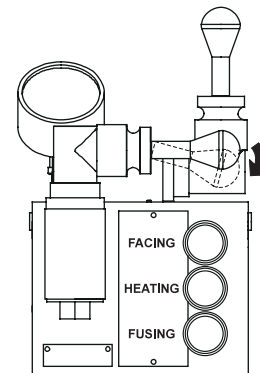

TX00376-9-15-94

CD00138E-9-12-94



# Operation



## Inserting Heater

**DANGER**

Heater Is Not Explosion Proof. This unit is not explosion proof. Operation of heater in a hazardous environment without necessary safety precautions will result in explosion and death.

If operating in a hazardous environment, heater should be brought up to temperature in a safe environment, then unplugged before entering the hazardous atmosphere for fusion.

Use a clean non-synthetic cloth to clean the butt fusion heater adapter surfaces.

Verify heater temperature by noting the reading on the dial thermometer.

Insert heater between the pipe ends.



PH02317-08-02



PH01094-2-20-97

TX00377-9-15-94

## Heating the Pipe

- A) Move the carriage to the left, bringing the heater into contact with both pipe ends.
- B) Move selector valve to center position once contact is established.
- C) If heating pressure is not required, allow the pressure to stabilize at the lowest setting and return carriage control valve to neutral position.

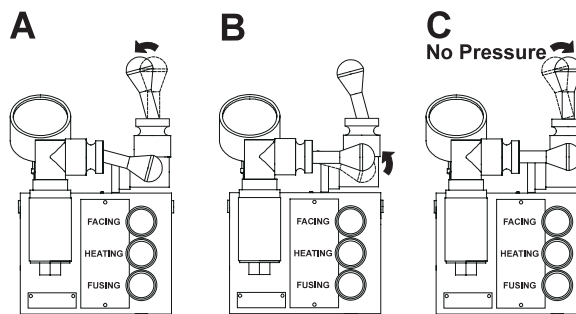

CD00140-9-12-94

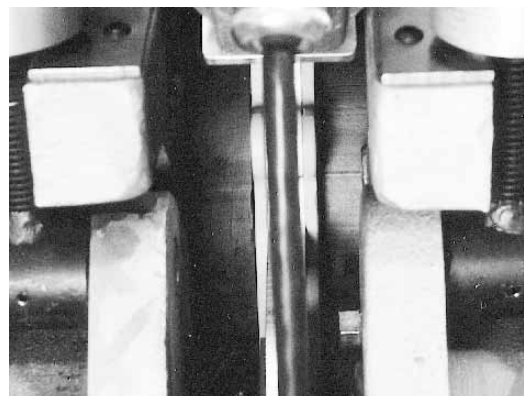

PH00367-9-12-94

TX00874-11-8-00



# Operation



## Fusing the Pipe



Failure to follow pipe manufacturer's heating time, pressure, and cooling time may result in a bad joint.

After following the pipe manufacturer's suggested heating procedure:

- A) Shift carriage control valve to neutral position, if it is not already in that position
- B) Shift the selector valve down to fusion position.

A

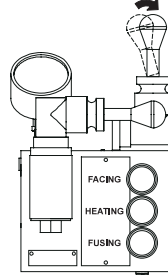

B

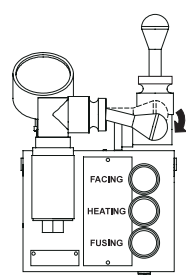

- C) Move the carriage to the right just enough to remove the heater.

**Quickly remove the heater.**

- D) Move the carriage to the left, bringing the pipe ends together under the pipe manufacturer's recommended pressure.

C

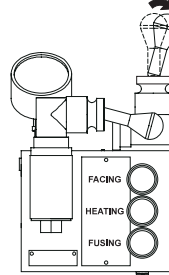

D

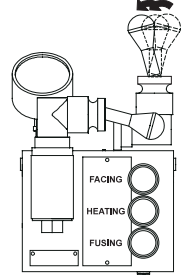

Allow joint to cool under pressure according to pipe manufacturer's recommendation.

TX02313-7-30-04

CD00141A-9-12-94

CD00141B-9-12-94

PH00363-9-12-94

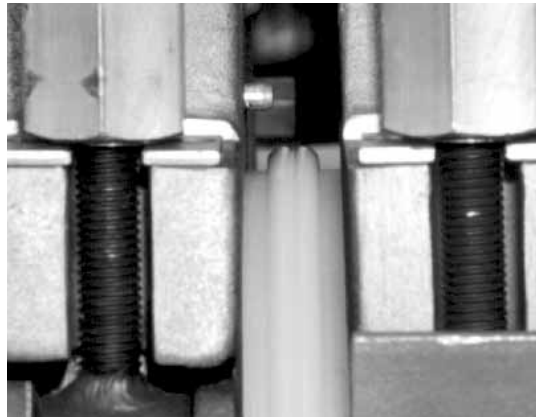

## Opening Movable Jaws

After the joint has cooled for the pipe manufacturer's recommended time, shift the carriage control valve to the neutral position.

Loosen all clamp knobs, and move carriage to the right far enough to open the jaw nearest the facer.

Open the movable jaws.

TX00380-9-15-94

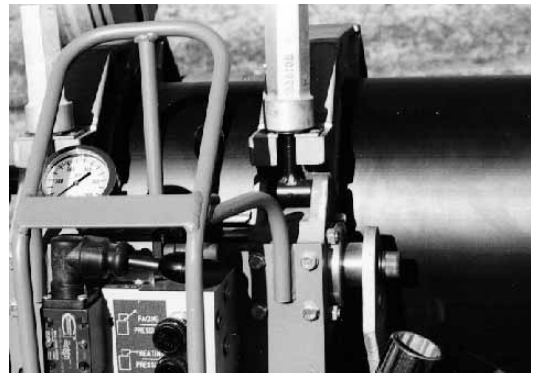

PH00323-9-25-93



# Operation



## Opening Fixed Jaws

Open the fixed jaws.

TX00381-9-16-94

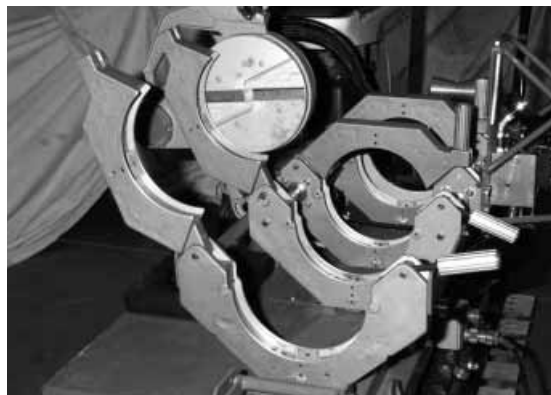

PH0245403-10-03

## Raise Pipe

Raise the joined pipe using the pipe lift. Push down on the pipe lift lever then release the latch. Pull the lever up to raise the pipe.

TX00382-9-16-94



PH01905-11-15-00

## Position Pipe for Next Joint

Drive the fusion machine to end of pipe, or pull the pipe through the jaws until the end of the pipe is protruding 1" past the jaw face of the fixed jaw.

TX00383-9-15-94

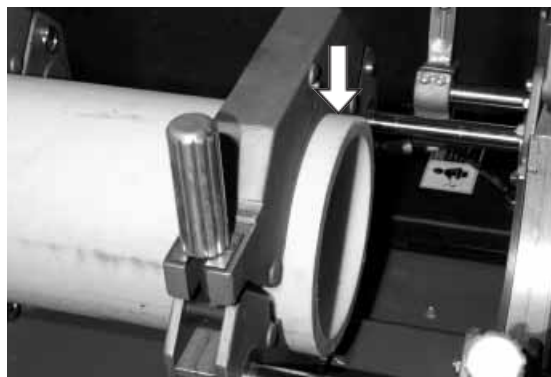

PH0244903-10-03

## Install Next Piece of Pipe

Insert a new piece of pipe in movable jaws and repeat all previous procedures.

TX00384-10-12-95



PH0246603-10-03



## Disconnect Hydraulic Hoses

There are two sets of hydraulic hoses. One set connects to the carriage hoses on the machine and to the carriage. The other set connects to the facer hoses on the machine and to the facer.

Disconnect both sets of hoses.

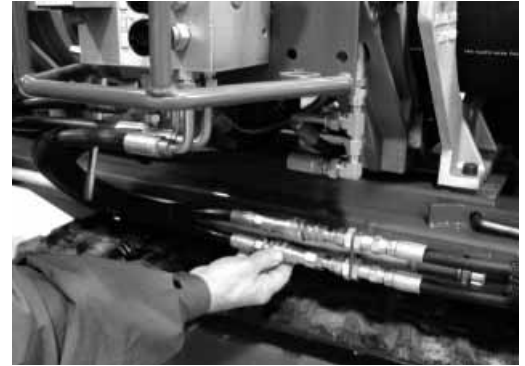

PH01911-11-1500



PH01908-11-1500

TX01992-1-10-02

## Remove Carriage Assembly from the Chassis



This equipment is not explosion proof. Operation of this equipment in a hazardous environment without necessary safety precautions will result in explosion and death. See safety section.

The carriage can be easily removed from the machine for fusing pipe on the ground or in the ditch. For especially tight conditions it is also possible to remove the outer fixed jaws and skid. The facer can be removed from the pivot shaft and used manually.

To remove the carriage, pull the pin at the rear of the machine and slide the carriage forward approximately one inch.

Attach lifting sling to the lifting points and the manifold bracket, then lift the carriage assembly.



PH01910-11-1500

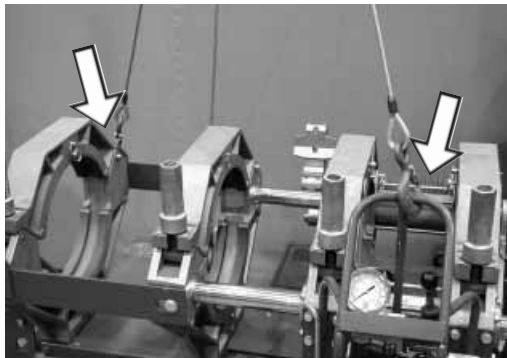

PH01937-11-1500

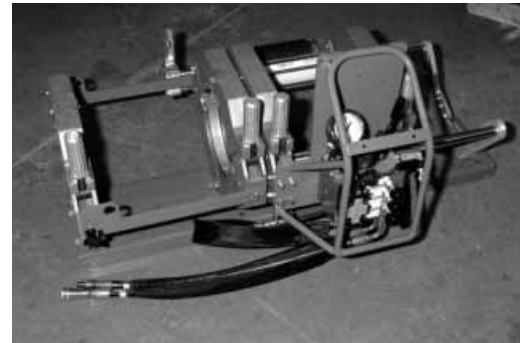

PH02442-03-10-03

TX02328-10-25-04



# Special Operations - In Ditch



## Remove 3-Jaw Assembly from the Carriage

Remove braces from inner fixed jaw.



Remove the four bolts holding carriage assembly to the chassis with the wrench provided.



Attach lifting strap as shown and lift the carriage assembly.

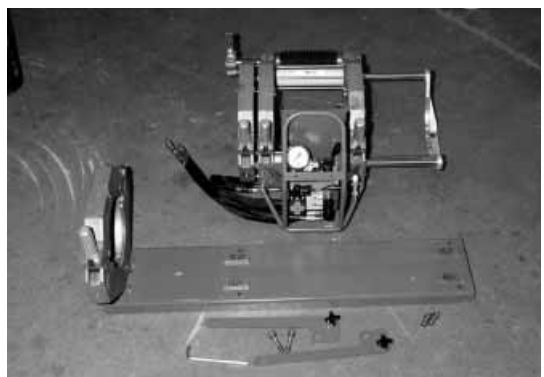





# Special Operations - In Ditch



## Remove Facer From TracStar 250 Machine

Loosen facer locking bolt.



PH02455-03-10-03

Lift facer out of the carriage and set on cardboard or wood blocks off of ground.

Remove rear guide rod bracket.



PH02462-03-10-03

Attach rear guide rod bracket in the position shown.



PH02461-03-10-03

TX02108-4-1-03



## Manual Facer Operation

Lift as shown.



PH02463-03-10-03

Lock onto back guide rod, then latch on front guide rod.

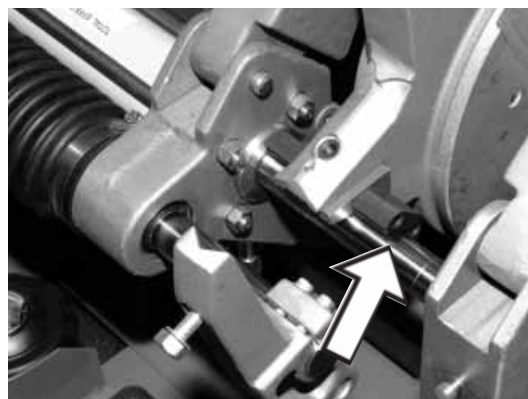

PH02464-03-10-03

TX01887-11-15-00

## Outrigger

The outrigger is an arm that is retractable and adds support to the carriage assembly when opening the jaws and pivoting the facer away from the carriage.

To extend or retract the outrigger, press the locking button near the base of the outrigger and push or pull the arm until the button snaps to the locked position.

**NOTICE:** Never use the outrigger to lift or move the carriage.



PH02698-04-29-04



PH02699-04-29-04

TX02304-04-29-04



# Special Operations - In Ditch



## Removing Top Jaws

If the carriage is going to be hand carried, or if the carriage needs to be hoisted and slid underneath the pipe, the top jaws need to be removed.

Loosen all clamp knobs. Take out the detent pins securing the top jaws and remove the jaws.

TX01479-2-26-98

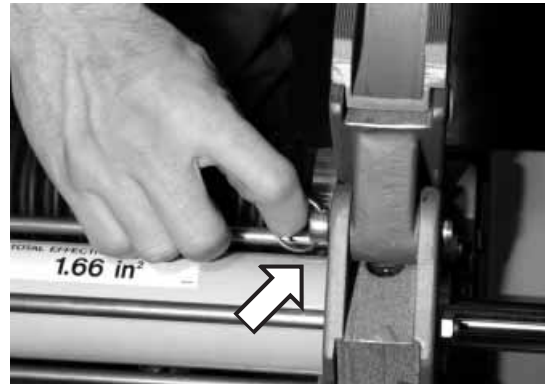

## Lower 3-Jaw or 4-Jaw Carriage into Ditch

Use all 4 jaws whenever possible. The three jaw unit should be used only when space is not available for the entire carriage, such as fusing onto a tee, an ell or doing saddle fusion

### 4-Jaw

Attach lifting sling to the manifold bracket and the near side lift point.

Lift carriage assembly and lower into ditch.

### 3-Jaw

Attach lifting sling to the manifold bracket.

Lift carriage assembly and lower into ditch.

TX01864-9-29-00

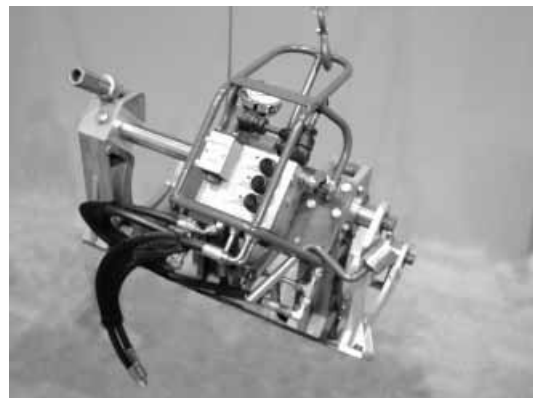
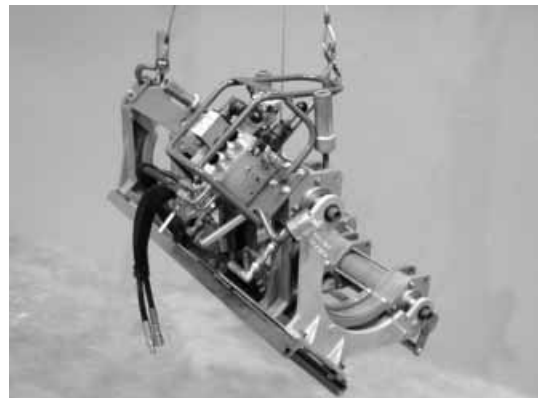



## Clamp Carriage Assembly to Pipe

Position carriage assembly on side of the pipe. Lift pipe and slide carriage assembly under pipe.

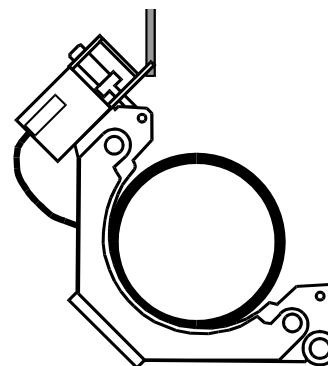

CD00193b-2-19-96

Rotate carriage assembly around to a normal upright position.

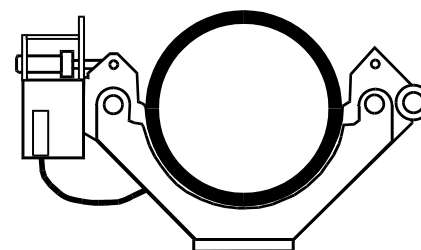

CD00194b-2-19-96

Attach the top jaws and loosely clamp around pipe.

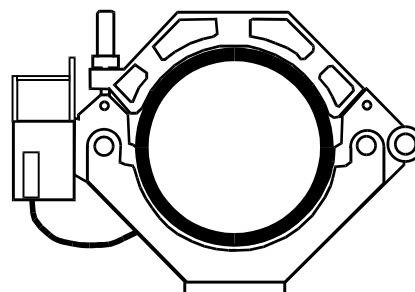

CD00195a-2-19-96

TX00879-2-19-96



# Special Operations - In Ditch



## Attach Hydraulic Hoses

There are two sets of hydraulic extension hoses. One set connects to the carriage hoses on the machine and to the carriage. The other set connects to the facer hoses on the machine and to the facer.

Connect all hoses.

TX01485-2-26-98



PH01908-11-15-00

## Make Fusion Joint

Refer to the "Butt Fusion Procedure" for operating instructions. After facing operation, remove the facer from ditch.

TX00450-9-16-94

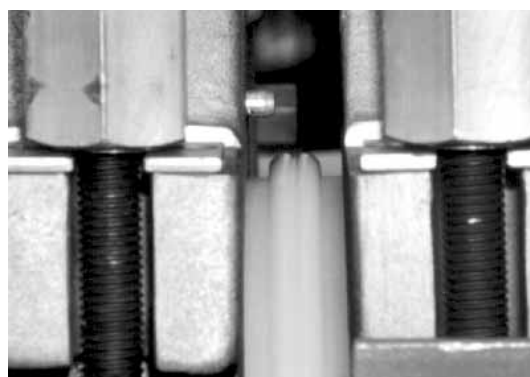

PH00363-9-12-94

## Remove Carriage Assembly from Ditch

Loosen clamp knobs and remove top jaws.

Rotate carriage assembly from under the pipe.

**IMPORTANT:** Always rotate unit with valve system facing up to protect against damage.

Attach sling to lifting point(s).

Lift carriage assembly from ditch.

TX00451-9-16-94

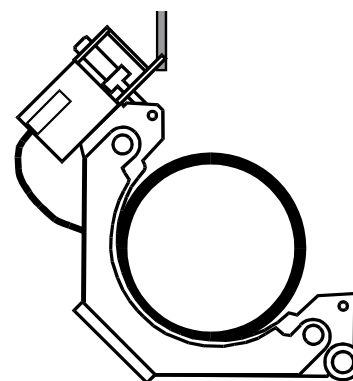

CD00193b-9-29-00

## Reassemble Fusion Machine

Install carriage assembly to the chassis and connect carriage hoses.

Lift facer into position and bolt to facer mount. Do not tighten. Pivot facer down and bring jaws inward against the facer to establish facer position. Open jaws away from facer and pivot facer out. Tighten the facer mounting bolts.

Connect facer hoses.

Replace top jaws.

TX02109-4-1-03

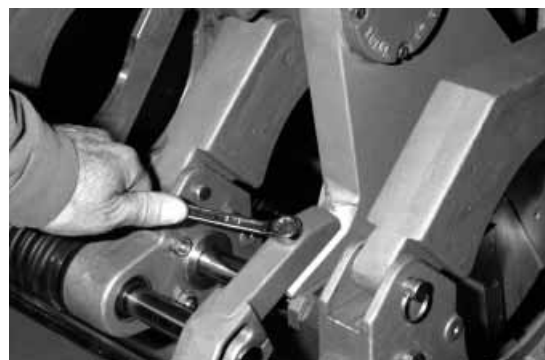

PH02455-6-3-05



## Heavy Overhead Load

**DANGER**

Fusion machine and plastic pipe are heavy. If loaded or lifted improperly, they could crush or kill. Handle load carefully with proper overhead rigging and equipment of adequate load rating.

TX00062-3-8-93

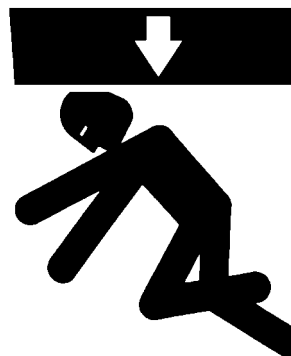

WR00014-3-8-93

## Crush Points

**WARNING**

Crush points exist on this machine. Keep hands and body parts away from the machine. Be aware of yourself and others when moving equipment.

TX01895-11-15-00



WR00012-12-4-92

## Required Equipment

- Proper overhead rigging and equipment of adequate load rating to lift the fusion machine.
- Lifting Sling - (supplied with machine)

**Notice:** Check all equipment to confirm that it is in good working order.



PH01955-11-15-00

TX01881-11-10-00



## Attach Slings

Attach the sling to the pick-up points. The cables are color coded to the chassis. Connect the yellow cables to the yellow lift points, etc. For machines that are not color coded, attach the longest leg cable at position A and the shortest leg cable at position B.

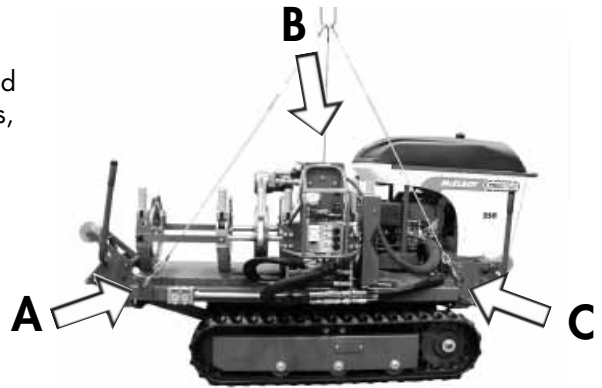

PH0248006-2003

TX02110-4-1-03

## Lifting Safety

Follow all applicable federal, state, local, and industry specific regulations when lifting unit.

Never carry loads over people.



SAFE1ST-12-14-92

TX00410-10-12-93



# Maintenance



## Preventative Maintenance

To insure optimum performance, the machine must be kept clean and well maintained.

With reasonable care, this machine will give years of service. Therefore, it is important that a regular schedule of preventive maintenance be kept.

Store machine inside, out of the weather, whenever possible.

TX00428-8-10-95

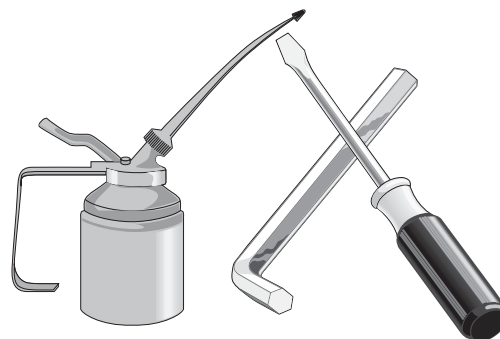

CD00142-11-2-94

## Washing the Machine

The machine should be cleaned, as needed with a soap and water wash.

TX00429-9-15-94



CD00178-9-29-00

## Check Hydraulic Fluid

The hydraulic fluid level should be checked daily.

Refer to the "Hydraulic Fluids" section of this manual for hydraulic oil recommendations.

If oil is not visible in the reservoir strainer, fill reservoir until oil is visible in the strainer. Do not overfill reservoir as the oil will expand as it heats up.

Never allow dirt, water or other foreign matter to enter the tank.

Use only clean oil from an unopened container.

TX02332-10-25-04



PH02714-10-25-04

## Change Hydraulic Fluid and Filter

The hydraulic fluid and filter should be replaced after every 400 hours of operation.

Fluid should also be changed as extreme weather conditions dictate.

Refer to the "Hydraulic Fluids" section of this manual for hydraulic oil recommendations.

TX00431-9-15-94

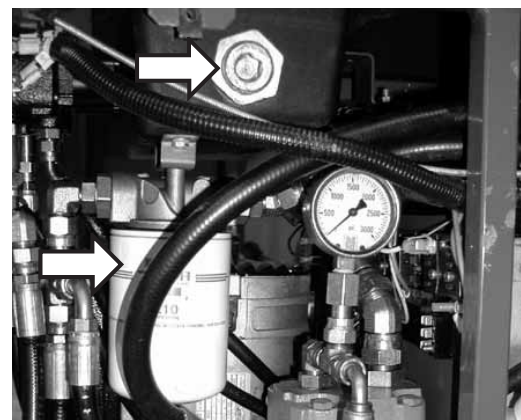

PH01916-11-15-00





## Install/Remove Covers

Hook top of cowl on three clips. Align the thumbscrew in the socket and tighten.

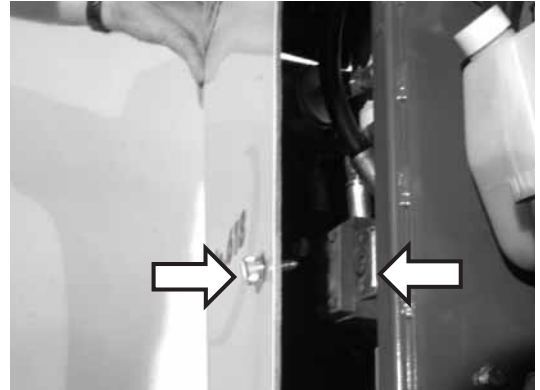

Align the rear latches and fasten the latch, making sure it locks. The cowl should be outside the dash panel



Align and fasten the front latch the same way.



Reverse the procedure to remove the cowls.





## TracStar No.250 Belt Tension Adjustment

Check the belt tension every 100 hours of operation.

The tensioner is located beside the rear pipe lift. Loosen the jam nut and tighten the spherical nut 6-10 ft lbs. Start the engine. If a belt slip or noise is detected, tighten the tensioner until it is eliminated but do not exceed 15 ft lbs. Lock the jam nut after adjusting

**NOTICE:** Overtightening will cause premature failure of engine and alternator bearings. If belt slip or noise continues at 15 ft lbs., clean the belt and try again. If noise continues, check sheave alignment.



PH01918-11-15-00

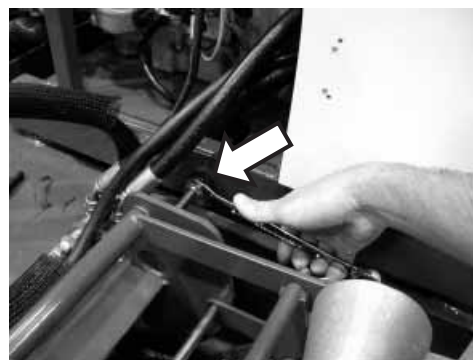

PH01957-11-15-00

TX02333-10-25-04

## Adjusting System Pressure

Remove the right side engine cover to gain access to the hydraulic pump.

Start the engine and select high speed.

The system pressure should be at 1800 psi on TracStar<sup>®</sup> 250.

To adjust the pressure, loosen the jam nut and turn the compensator to the right to increase the pressure, or to the left to decrease pressure. Retighten the jam nut.

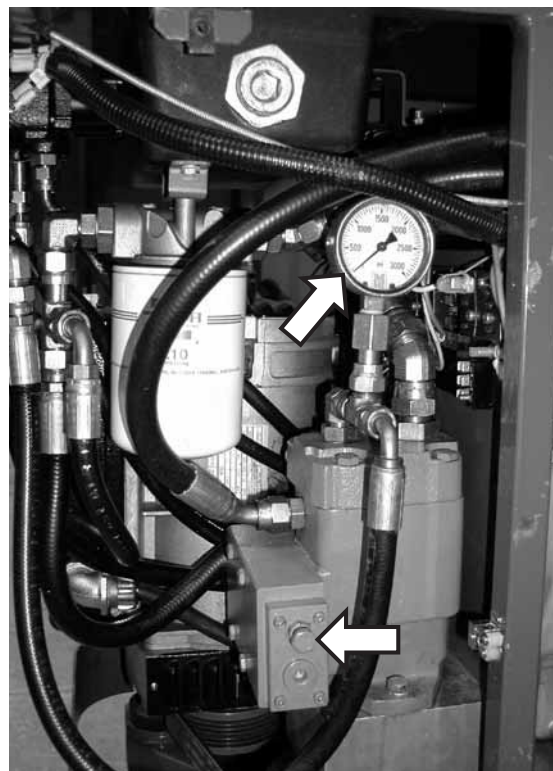

PH01917-11-15-00

TX02111-4-1-03



## Engine Oil System - Gasoline

Change engine oil after the first 20 hours of operation. After the first oil change, change the oil and filter every 100 hours of operation. Read the engine maintenance instructions and use the appropriate oil for the ambient temperature.

The oil drain plug is located on the bottom of the oil pan.

The oil filler cap and dip stick are located on top of the engine.

TX02336-10-25-04

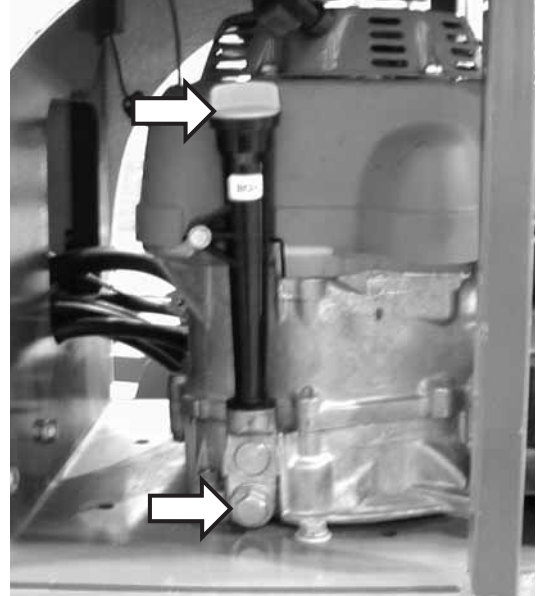

PH01971-11-15-00

## Check Gauge

The gauge should read zero when the unit is not running. Damaged gauges should be replaced.

TX02291-3-8-04

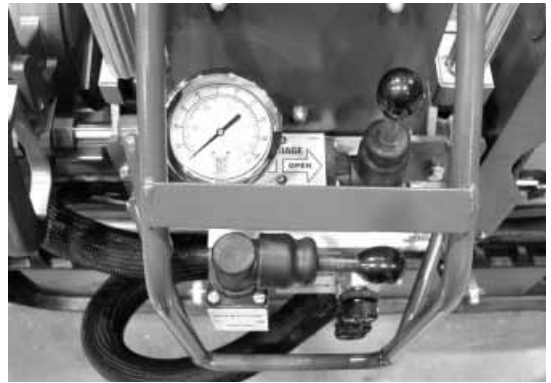

PH01972-11-15-00

## Clean Jaws and Inserts

To prevent slippage and insure proper alignment, the jaws and inserts must be clean.

Clean the jaws and inserts of any dirt or residual material using a stiff-bristled brush.

TX00433-9-15-94



PH02687-6-3-05



## Clean Thrust Bearings

The thrust bearings located in the clamp knobs must turn freely. Wash the clamp knob bearing assembly with a solvent, and then lubricate with 30W or lighter oil.

TX00434-9-13-94

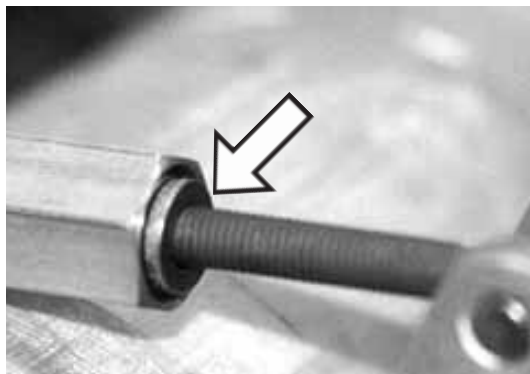

PH00377-9-14-94

## Clean Eyebolt Threads

Keep the clamp knob eyebolt threads brushed clean.

TX00435-9-13-94

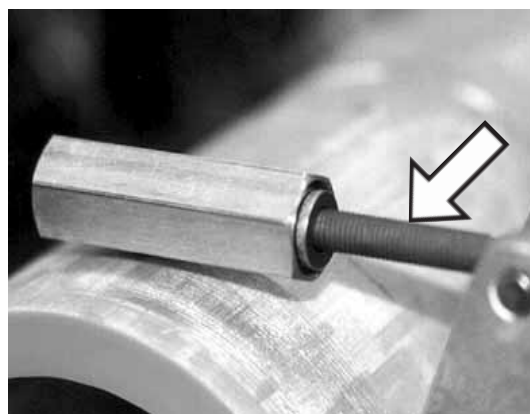

PH00377-9-14-94

## Fasteners Must Be Tight

Check all nuts, bolts, and snap rings to make certain they are secure and in place.

TX00437-9-13-94



PH00433-1-1-94

## Facer Blades

Blades bolt directly to the blade holder and should be inspected for damage and sharpness.

Dull or chipped blades must be replaced.

**NOTICE:** Never extend the blade beyond the inner or outer circumference of the facer.

TX02475-3-29-05

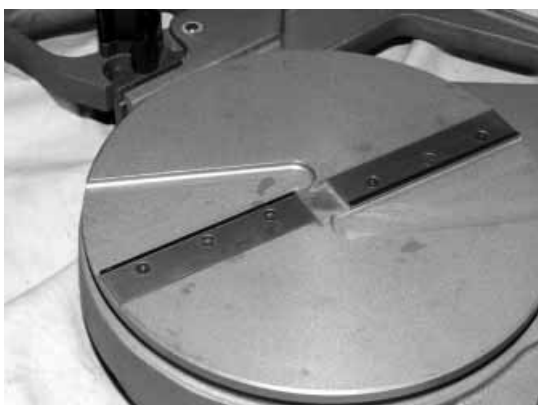

PH02465-03-10-03



## Clean Heater Surfaces

The heater faces must be kept clean and free of any plastic build up or contamination.

Before and after each fusion joint the heater surfaces must be wiped with a clean, non-synthetic cloth.

**NOTICE:** Do not use an abrasive pad or steel wool. Use a non-synthetic cloth that won't damage surfaces.

TX00440-9-13-94



PH023177-08-02

## Bleeding Air From Hydraulic System

The two carriage cylinders have air bleed screws and must be bled if the system ever runs low on oil or leaks air on inlet side of pump. Air in the system is indicated when carriage movement becomes jerky and erratic. To bleed the system, proceed as follows:

Remove upper jaws & clamping eye bolts from the two movable clamp jaws to expose the bleed plugs recessed in top of the lower jaws.

Tilt machine so the fixed jaw end is higher than the opposite end.

Shift the directional control and move the carriage to the fixed jaw end. Adjust the pressure to approximately 50-100 psi before proceeding.

Loosen the bleed plug on one cylinder next to the fixed jaw.

Hold pressure on the cylinder until no air is indicated and quickly tighten the plug.

Repeat this operation on the opposite cylinder.

Tilt the machine so the opposite end is higher than the fixed jaw end. Move the carriage to the end opposite the fixed jaw and repeat the above procedure on the this end of the cylinders.

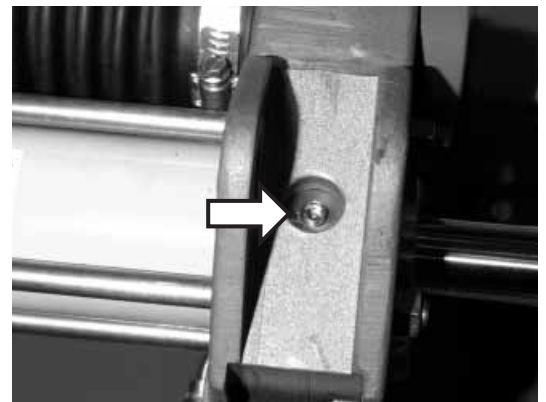

PH02467-03-10-03

PH02468-03-10-03

TX00427-9-15-94



## Installing Butt Fusion Heater Plates

The heater body of this assembly is not coated. Coated butt fusion heater plates are available for all butt fusion applications.

Butt fusion heater plates are installed with eight Stainless Steel Cap Screws.

Care should be taken to assure that the butt fusion heater plates are seated on the heater body, and that there is no foreign matter trapped between these surfaces.

**IMPORTANT:** Do not over tighten the bolts.

The surface of the butt fusion heater plates are coated with an antistick coating.



PH02333-7-08-02

TX02311-7-30-04

## Adjusting Heater Temperature

Turn knob to desired temperature. Measure the heater surface temperature with a pyrometer. Any variance must be corrected to the pyrometer reading.

Loosen setscrew in the knob. Turn knob to point to the same temperature as the pyrometer. Tighten setscrew in the knob.

Turn knob to desired temperature. Allow heater to stabilize at the new temperature (5 to 10 minutes) after adjusting.

The thermometer on the heater body indicates internal temperature and should be used as a reference only.

TX02034-7-08-02



PH02313-7-08-02

## Heater Indicator Light

The heater has a green indicator light which will flash on and off. This indicates that the controller is operating normally. If the green indicator is not flashing then the controller may not be operating properly. If this occurs, disconnect power and have the heater repaired by an McElroy Authorized Service Center.

The heater has a red indicator light on the handle at the bottom of the temperature scale. When the heater is plugged in and preheating the light glows steadily until the set temperature is reached. The light then goes off and on slowly as the heater maintains temperature.

If the heater is not operating properly, the control will attempt to turn the heater off and the indicator light will flash rapidly. If this occurs, disconnect the power and take it to a McElroy Authorized Service Center for repair.

TX02213-09-16-03



PH02314-7-08-02

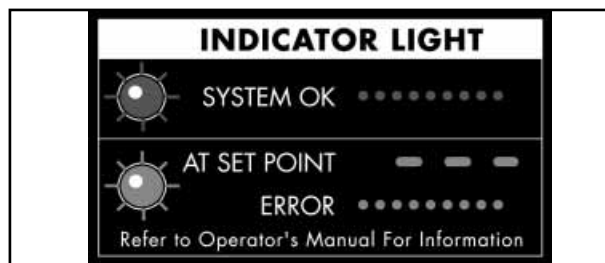

PH02571-09-16-03



# Maintenance



## Engine Maintenance

Refer to the operation and maintenance manual for the engine.



TX01500-3-5-98

## Checking Track Tension

Park the machine on a flat solid surface.

Use the lifting sling to raise machine off the ground.

Place adequate supports under the the bottom frame after lifting.

Measure the deflection between the bottom center roller and the inside surface of the rubber track. Track tension is normal when this distance is about 1/2". If the deflection is more or less than this, the tension needs to be adjusted.

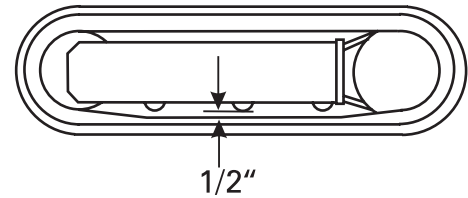

TX01885-11-10-00



## Adjusting Track Tension

### **⚠ WARNING**

The grease in the hydraulics of the track is pressurized. If the grease valve is loosened too much, grease can be expelled at high pressure and cause serious injury. Never loosen grease valve more than one turn. Injury could also result if the grease nipple is loosened. Never loosen the grease nipple.

Remove screws and cover to access the adjustment system.

To loosen the track, turn hex shaped valve ① counterclockwise no more than 1 turn. If grease does not start to drain out, then slowly rotate the track. When correct track tension is obtained, turn valve clockwise and tighten it. Clean off any expelled grease.

To tighten the track, connect a grease gun to the nipple ② and add grease to the system. When the track stretches to the correct tension, stop adding grease. Clean off any excess grease.

Replace access cover.

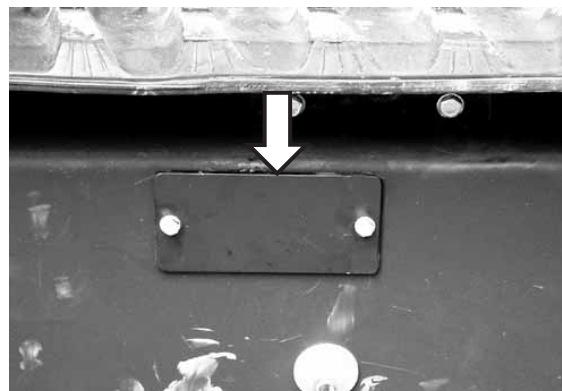

PH01283-2-25-98

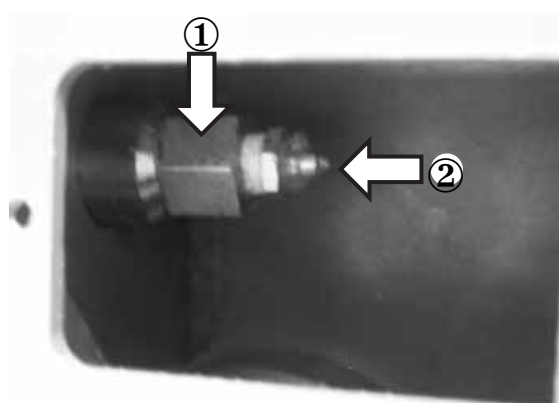

PH01979-11-15-00

TX01898-11-15-00

## Setting Engine Speed

With the engine running at max speed plug the heater in. Put a volt meter in the unused receptacle. Make sure the throttle is in the detented position.

Adjust throttle cable sheath until voltage is correct.

The TracStar<sup>®</sup> 250 should read 120V±2.



PH01987-6-6-05

TX02112-4-1-03





# Maintenance Checklist



## Fusion Machine Checklist

Items to Check	Satisfactory	Needs Repair	Repair Comments
<b>UNIT</b>			
Machine is clean			
All pins and snaprings are in place			
All nuts and bolts are tight			
All identification placards and handles are in place			
All clamp knobs are lubricated and turn freely			
Wiring, battery cables, & all electrical terminals			
Cords and plugs are in good condition			
All hardware is on the basic machine			
Hydraulic oil level is correct			
No oil or water leaks (engine and hydraulic system)			
Hydraulic gauge reads correctly			
Rubber tracks in good condition			
Fuel tank full			
Engine crankcase is filled to correct level			
Cooling system level is correct			
Hydraulic hoses are in good condition			
Engine starts and runs properly			
Jaws are properly aligned			
Facer pivot operates properly			
Facer operates smoothly			
Face-off is square			
Inserts fit and pin properly			
Voltage to heater is correct			
Carriage and Selector Valves operate smoothly			
Pressure Reducing Valves operate in their range			
Heater Cord and plug are in good condition			
Heater surface is clean and in good condition			
Thermometer is in good working order			
Surface temperature checked with pyrometer			
Throttle control works properly			
Low Oil /alarm works (diesel only)			
Primary pump pressure (1800 psi)			
Hydraulic carriage works smoothly			
Check receptacles for damage			



# Determining Fusion Pressure



## Variable Definitions

- O.D. = Outside Diameter
- t = Wall Thickness
- $\Pi$  = 3.1416
- SDR = Standard Dimensional Ratio
- IFP = Manufacturer's Recommended Interfacial Pressure
- TEPA = Total Effective Piston Area

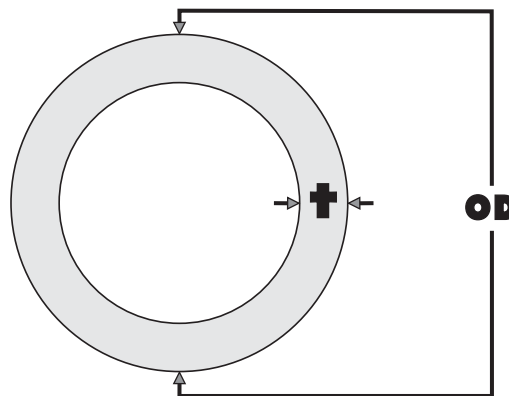

## Formulas

$$t = \frac{\text{O.D.}}{\text{SDR}}$$

$$\text{AREA} = (\text{O.D.} - t) \times t \times \Pi$$

$$\text{FORCE} = \text{AREA} \times \text{IFP}$$

$$\text{GAUGE PRESSURE} = \frac{(\text{O.D.} - t) \times t \times \Pi \times \text{IFP}}{\text{TEPA}} + 30 \text{ P.S.I. DRAG}$$

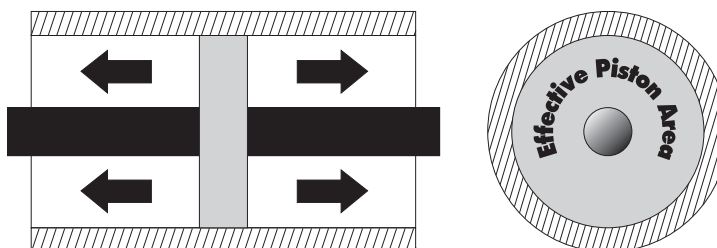

## Example

Pipe Size = 8" IPS

O.D. of Pipe = 8.625

SDR of Pipe = 11

Recommended Interfacial Pressure = 75 PSI

Using a Model 28 Fusion Unit

$$t = \frac{\text{O.D.}}{\text{SDR}} = \frac{8.625}{11} = 0.784$$

TEPA = 4.710 (From Table)

$$\text{GAUGE PRESSURE} = \frac{(\text{O.D.} - t) \times t \times \Pi \times \text{IFP}}{\text{TEPA}} + 30 \text{ P.S.I. DRAG}$$

$$\text{GAUGE PRESSURE} = \frac{(8.625 - .784) \times .784 \times 3.1416 \times 75}{4.710} + 30 \text{ P.S.I. DRAG} = 338 \text{ PSI}$$

**Total Effective Piston Areas**

Fusion Model	High Force (Standard)	Medium Force (High Velocity)	Low Force (Extra High Velocity)
250	4.71	-	1.67
412	11.78	6.01	3.14
618	11.78	6.01	3.14
824	29.44	15.32	9.45
1236	29.44	15.32	9.45
1648	31.42	14.14	-
2065	31.42	-	-



# Hydraulic Fluids



## Hydraulic Fluids

The use of proper hydraulic oil is mandatory to achieve maximum performance and machine life. Use a clean, high quality, anti-wear hydraulic oil with a viscosity index (VI) of 135 minimum. It should have a maximum viscosity of 500 cSt (2000 SSU) at startup (ambient temperature) and a minimum viscosity of 13 cSt (65 SSU) at the maximum oil temperature (generally 80°F above ambient). Using hydraulic oils that do not meet these criteria may cause poor operation and/or damage to the hydraulic components.

The following table specifies the oil temperature at various viscosities. Temperature rise of the hydraulic oil can vary from 30° F to about 80° F over the ambient temperature depending on the pressure setting, age of the pump, wind, etc. Exxon Univis N46 hydraulic oil is installed at our factory. The advantage of this oil is a wider temperature range, however, this oil should not be used for continuous operation below 20° F. For use in extremely cold ambient temperatures, we suggest Mobil DTE 11M, which can be used to -16° F. This oil should not be used for continuous operation above 100° F (oil temperature).

TX02244-2-2-04

Hydraulic Fluids Characteristics																
Manufacturer	Fluid Name	SSU 100F	SSU 210F	V.I.	-20F	-10F	0F	10F	30F	50F	70F	90F	110F	130F	150F	Range °F
Mobil	DTE 11M	87	40	145	*****	*****	*****	*****	*****	*****	*****	*****	*****	*****	*****	-27-87
	DTE 13M	165	48	140				*****	*****	*****	*****	*****	*****	*****	*****	5-130
	DTE 15M	225	53	140				*****	*****	*****	*****	*****	*****	*****	*****	5-140
Exxon	Univis N-32	177	49	164				*****	*****	*****	*****	*****	*****	*****	*****	5-140
	Univis N-46	233	55	163					*****	*****	*****	*****	*****	*****	*****	25-142
	Univis N-68	376	68	160						*****	*****	*****	*****	*****	*****	34-155

NOTE: This chart is based on pump manufacturer recommendations of 65 to 2000 SSU limits.

NOTE: Temperatures shown are fluid temperatures. – NOT ambient temperatures.



# Specifications



## TracStar<sup>®</sup> 250 Fusion Machine Specifications:

- Engine: 11HP, OHV, Air Cooled
- Starting System: Electric and Recoil
- Fuel Type: Gasoline
- Fuel Tank Capacity: 5 Gals.
- Operational Tank Capacity: 8 Hrs.
- System Pressure: 1800 PSI
- Hydraulic Reservoir Capacity: 8 Gals
- Vehicle Speed: 2.5 MPH
- AC Output: 120, 240 V, 60Hz, 15 Amp
- Entire Machine Weight: 1320 lbs (598.7kg)
- 3-jaw Carriage Weight: 185 lbs (83.9kg)
- 4-jaw Carriage Weight: 230 lbs (104.3kg)
- Facer Weight: 39 lbs (17.7kg)
- Heater Weight: 17 lbs (7.7kg)

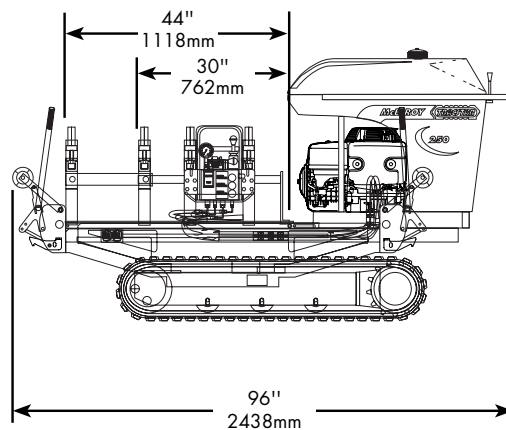
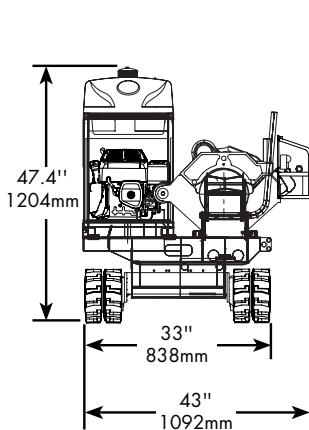

## **About this manual . . .**

McElroy Manufacturing continually strives to give customers the best quality products available. This manual is printed with materials made for durable applications and harsh environments.

This manual is waterproof, tear resistant, grease resistant, abrasion resistant and the bonding quality of the printing ensures a readable, durable product.

The material does not contain any cellulose based materials and does not contribute to the harvesting of our forests, or ozone-depleting constituents. This manual can be safely disposed of in a landfill and will not leach into ground water.

TX001660-8-19-99



---

**The leader by design.**

---

P.O. Box 580550 Tulsa, Oklahoma 74158-0550, USA  
**[www.mcelroy.com](http://www.mcelroy.com)**